

### Features

- Column lets you customize your shower with a showerhead and handshower
- Arched shower arm makes it possible to install with low ceiling heights
- Slidebar bracket allows you to adjust the height and angle of the handshower
- Diverter at base of column makes for easy toggling between handshower and showerhead
- Rainhead, handshower, and hose sold separately to allow for customized components

### Material

- KOHLER finishes resist corrosion and tarnishing
- Premium metal construction for durability and reliability

### Installation

- Wall-mount shower-only installation
- Installs in less than 60 minutes without changes to in-wall plumbing (subject to condition of existing installation)
- Includes an adapter that will fit with most installations but may require K-1194630, K-1187917 or K-1194302

### Adapters, Rough-in and Extension Kits

1187917	Range: 0" (0 mm) - 1-3/8" (35 mm)
1194630	Range: 2-7/8" (73 mm) - 4" (102 mm)
1194302	Range: 1-1/4" (32 mm) - 2-1/4" (57 mm)

### Included Components

Additional Components:  
 Adapter  
 Diverter  
 Handshower bracket  
 Slidebar



ADA

### Codes/Standards









ASME A112.18.1/CSA B125.1  
 ADA

### KOHLER<sup>®</sup> Faucet Lifetime Limited Warranty

See website for detailed warranty information.

### Available Colors/Finishes

*Color tiles intended for reference only.*

Color	Code	Description
	CP	Polished Chrome
	SN	Vibrant™ Polished Nickel
	BN	Vibrant™ Brushed Nickel
	BV	Vibrant™ Brushed Bronze
	2BZ	Oil-Rubbed Bronze
	BL	Matte Black
	2MB	Vibrant™ Brushed Moderne Brass
	TT	Vibrant Titanium

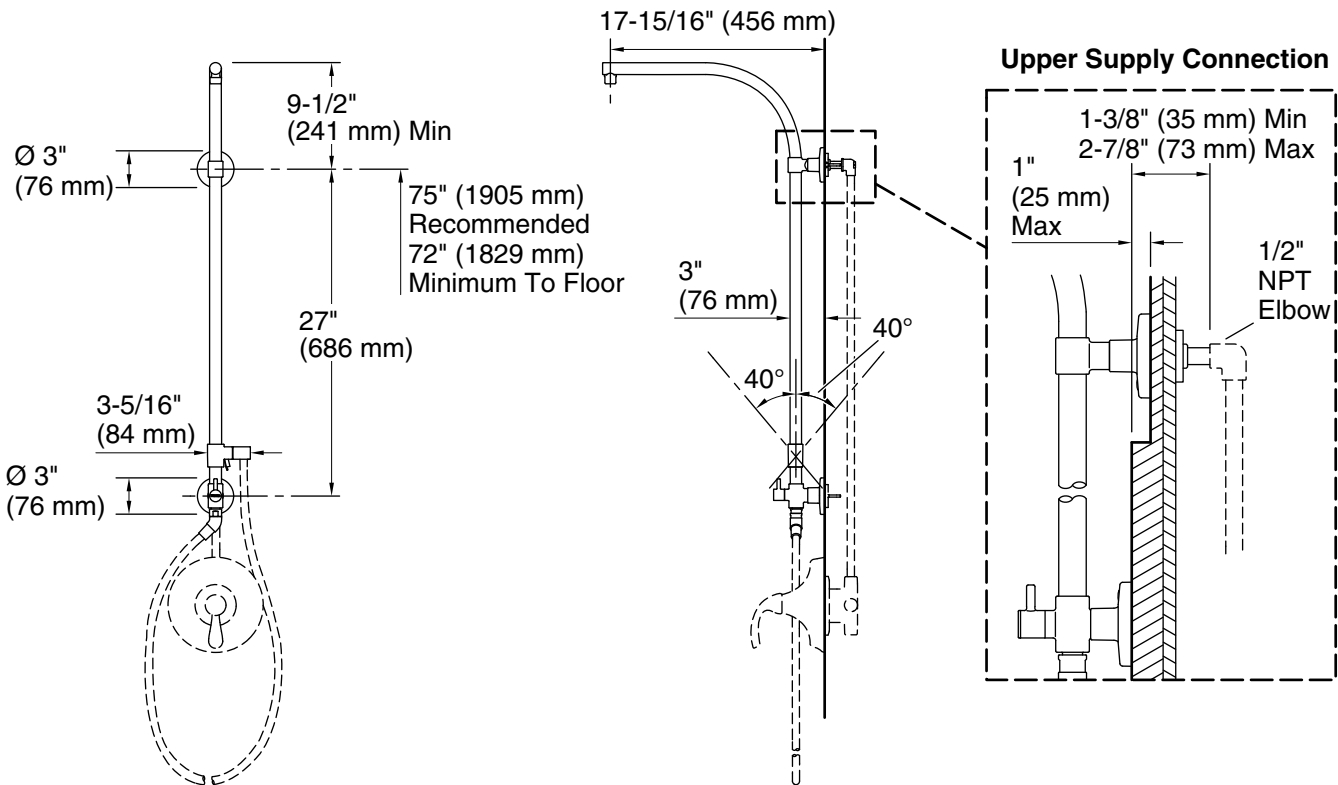

**NOTE:** Valve trim and hose illustrated for dimensioning only, not included in the product.

### Technical Information

All product dimensions are nominal.

Drain included: No

### Notes

Install this product according to the installation guide.

Order deep roughing-in kit if the distance from the elbow to the finished wall surface is between  $2\text{-}7/8''$  (73 mm) to  $4''$  (102 mm).

Order shallow roughing-in kit if the distance from the elbow to the finished wall surface is less than  $1\text{-}3/8''$  (35 mm).

Order large escutcheon/mounting collar kit if the supply connection hole diameter is between  $1\text{-}1/4''$  (32mm) to  $2\text{-}1/4''$  (57 mm).

A  $3''$  (76 mm) escutcheon/mounting collar is supplied to fit a  $1''$  (25 mm) to  $1\text{-}1/4''$  (32 mm) supply connection hole diameter.

ADA compliant for shower-only installations.

ADA compliant when installed to the specific requirements of these regulations.